

Socket illustration

PYF-08A

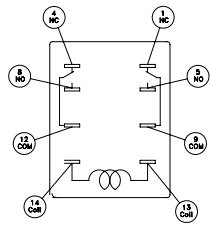

Terminal illustration



Equipment

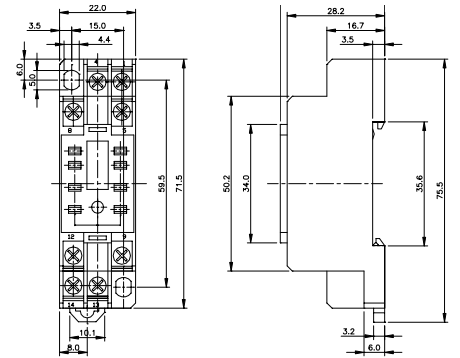

Appearance illustration

PYF-08AE

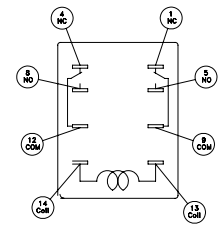

Terminal illustration



Equipment

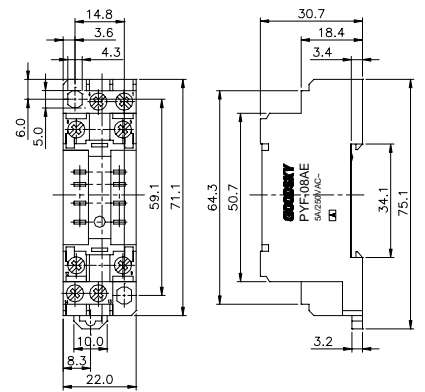

Appearance illustration

PYF-14A

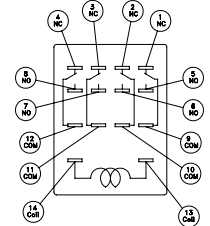

Terminal illustration



Equipment

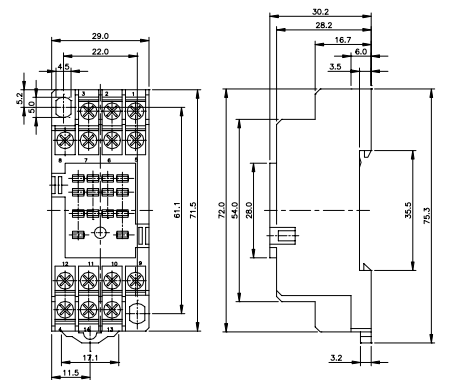

Appearance illustration

PYF-14AE

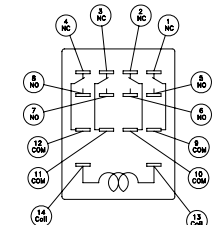

Terminal illustration



Equipment

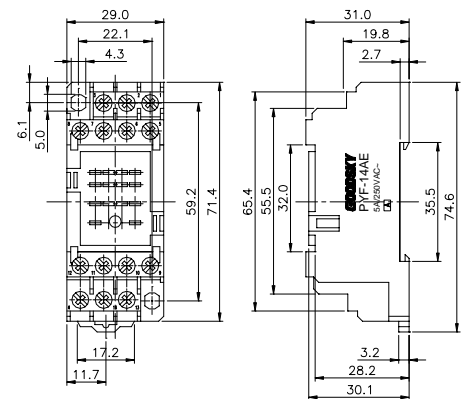

Appearance illustration

Socket illustration

PTF-08A

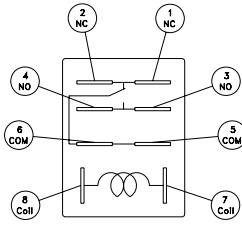
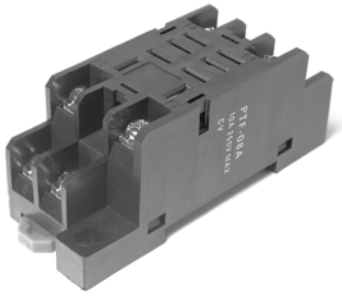

Terminal illustration



Equipment

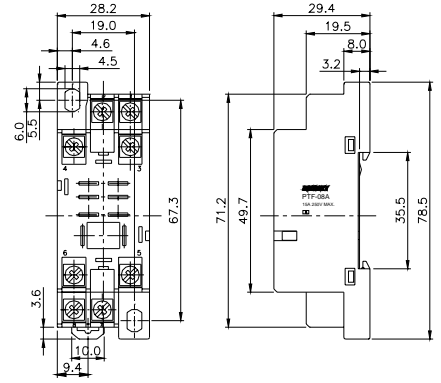

Appearance illustration

PTF-08AE

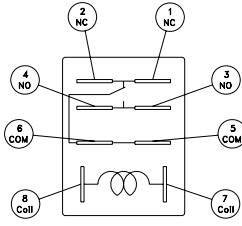
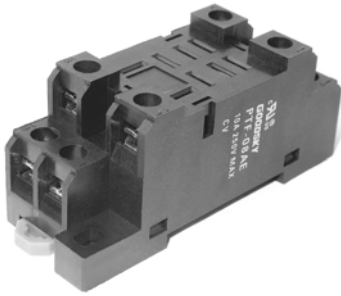

Terminal illustration



Equipment

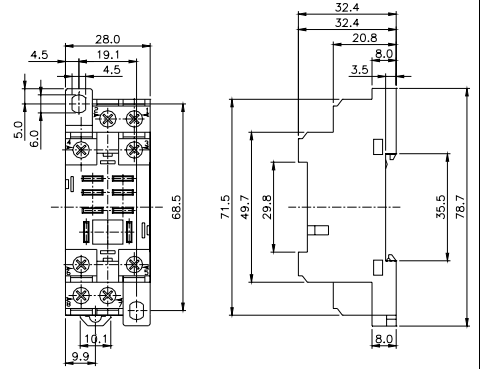

Appearance illustration



PTF-14A

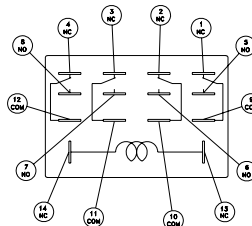

Terminal illustration



Equipment

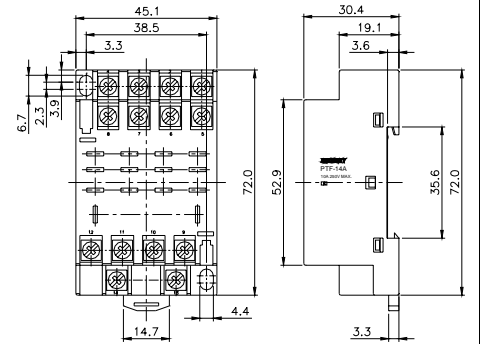

Appearance illustration

PTF-14AE

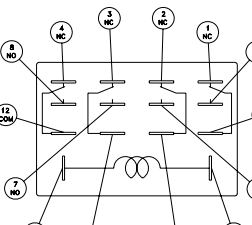
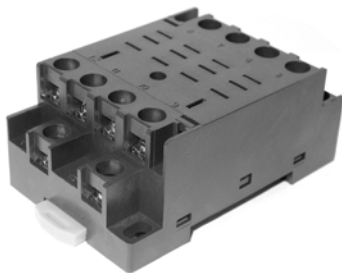

Terminal illustration



Equipment

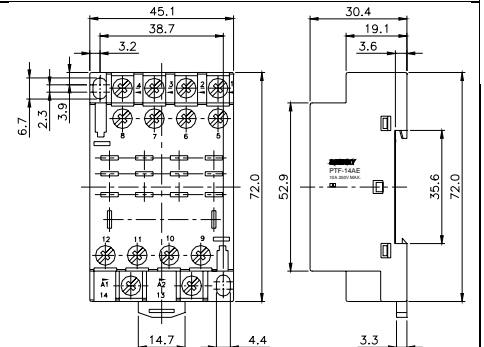

Appearance illustration

Socket illustration

PY-08

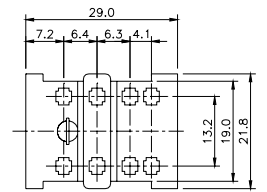
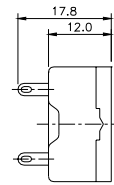
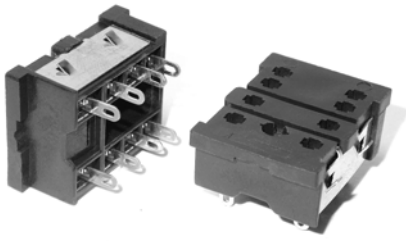

Equipment

Appearance illustration

PY-08-0

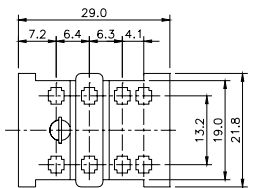
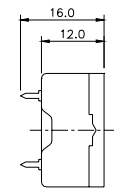
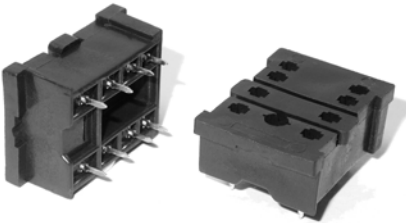

Equipment

Appearance illustration

PY-14

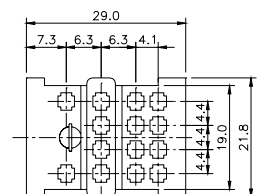
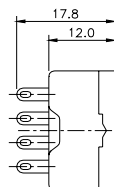
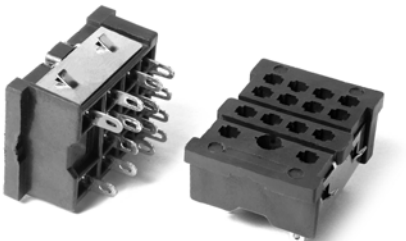

Equipment

Appearance illustration

PY-14-0

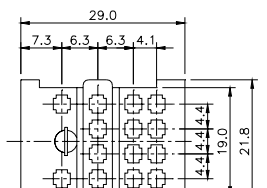
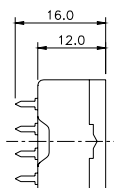
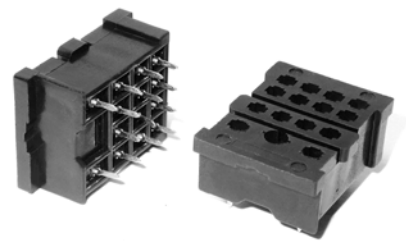

Equipment

Appearance illustration

Socket illustration

PT-08

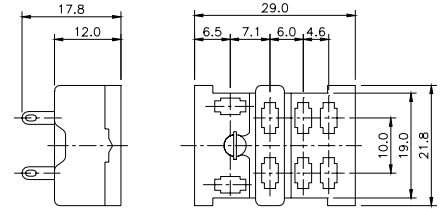
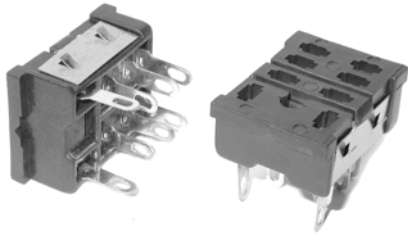

Equipment

Appearance illustration

PT-08-0

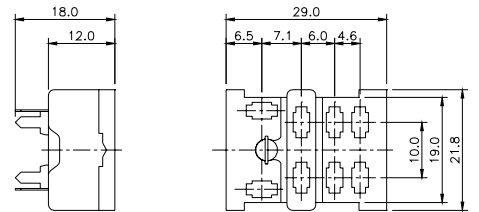
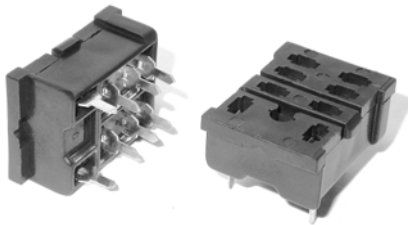

Equipment

Appearance illustration

PF-083A

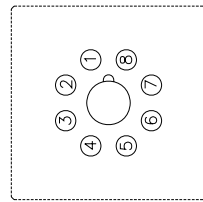

Terminal illustration

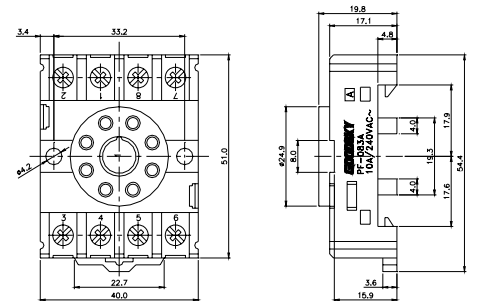

Equipment

Appearance illustration

PF-083AE

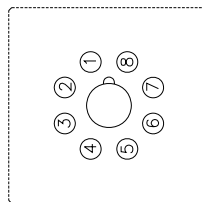

Terminal illustration

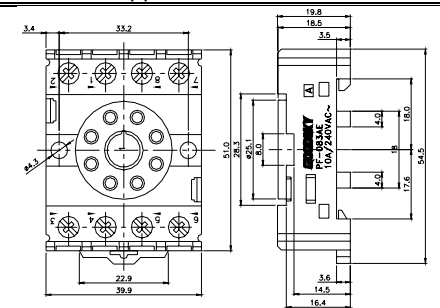

Equipment

Appearance illustration

Socket illustration

PYF-08BE

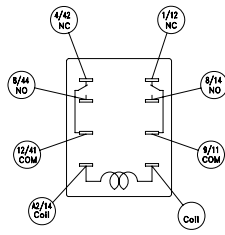

Terminal illustration

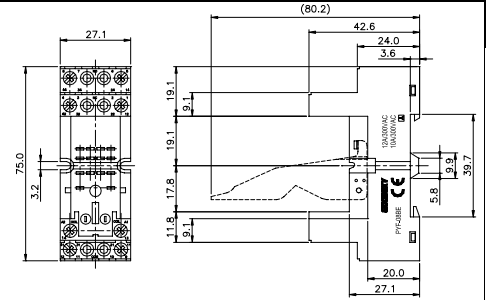

Appearance illustration



Equipment

PYF-14BE

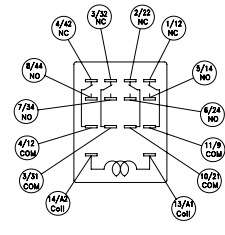

Terminal illustration

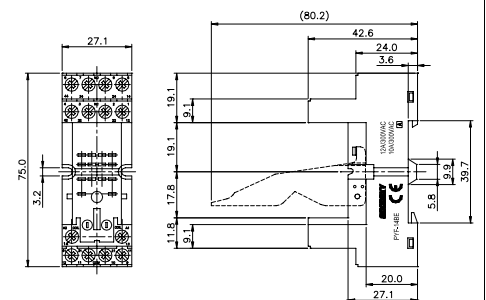

Appearance illustration



Equipment

PYF-08BE/3

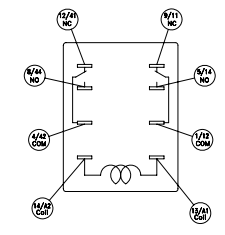

Terminal illustration

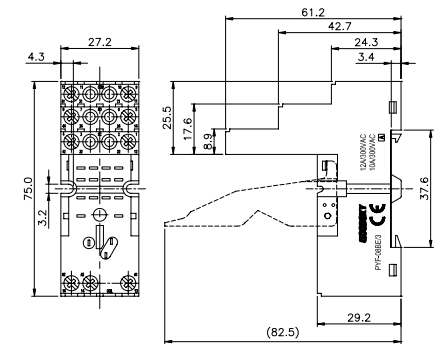

Appearance illustration



Equipment

PYF-14BE/3

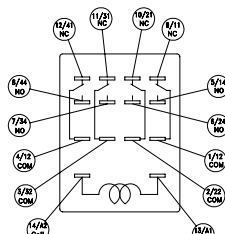

Terminal illustration

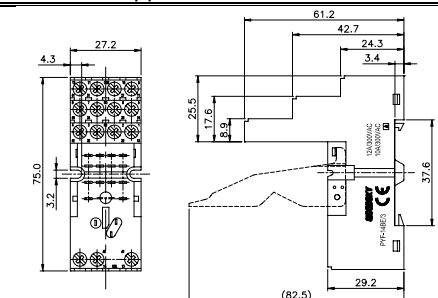

Appearance illustration



Equipment

Socket illustration

PI-35BE

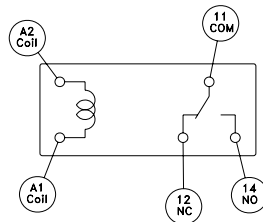

Terminal illustration



Equipment

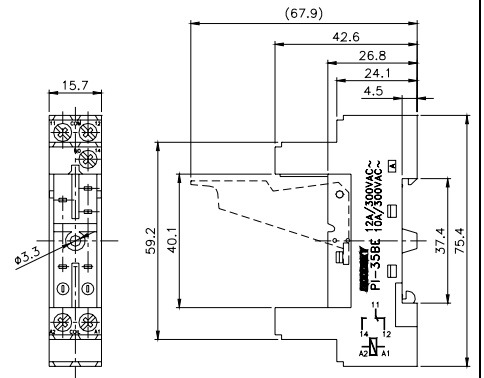

Appearance illustration

PI-50BE

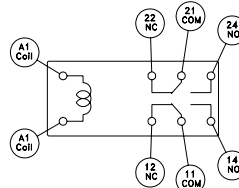

Terminal illustration



Equipment

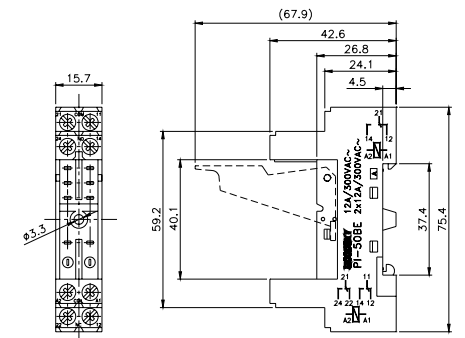

Appearance illustration

PI-35BE/3

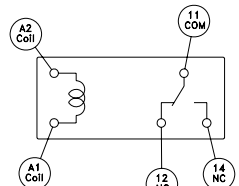

Terminal illustration



Equipment

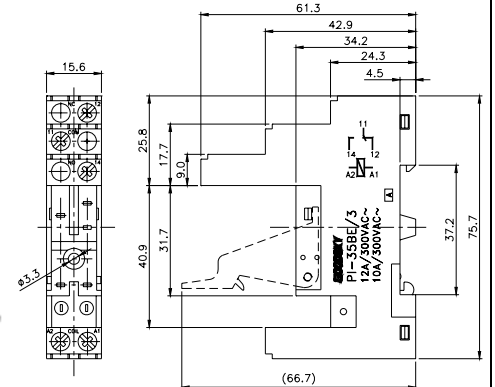

Appearance illustration

PI-50BE/3

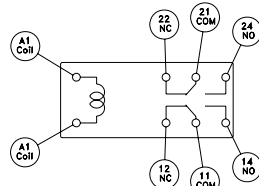

Terminal illustration



Equipment

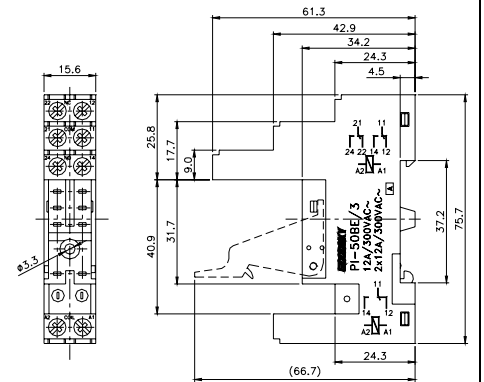

Appearance illustration

Socket illustration

PF-083BE

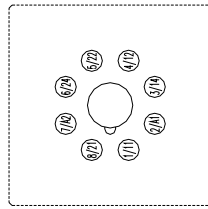

Terminal illustration

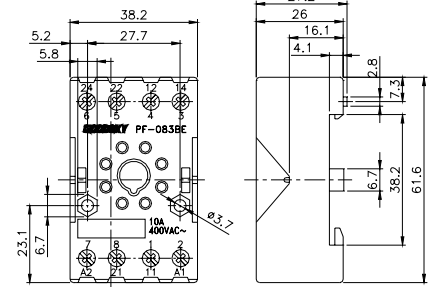

Appearance illustration

PF-113BE

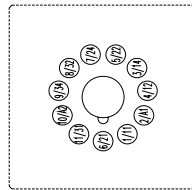

Terminal illustration

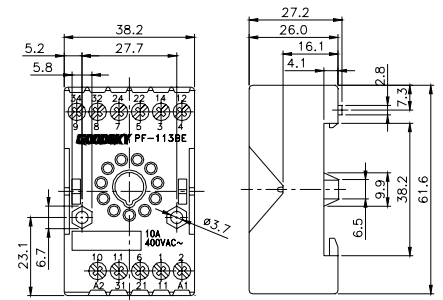

Appearance illustration

PI-35-0

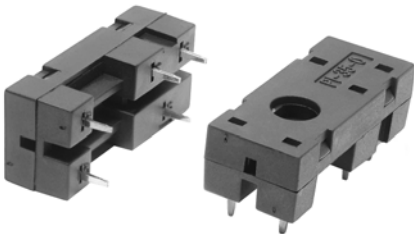

(16/20/25mm)

(Metal)



(16/20/25mm)

(Plastic)

Equipment

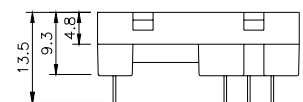
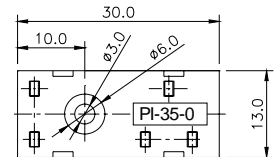

Appearance illustration

PI-50-0

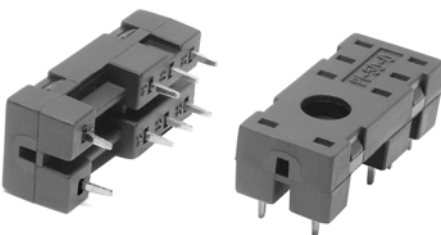

(16/20/25mm)

(Metal)



(16/20/25mm)

(Plastic)

Equipment

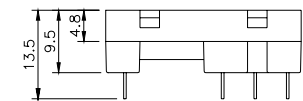
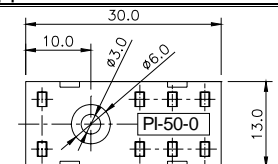

Appearance illustration

Socket illustration

UC3003

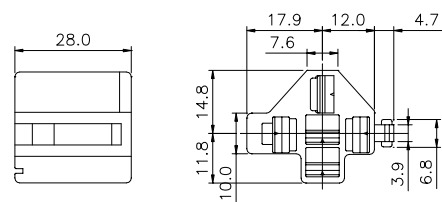

Appearance illustration

CS3770

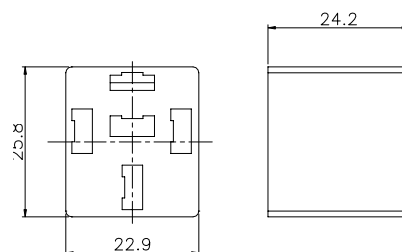

Appearance illustration

UC3001

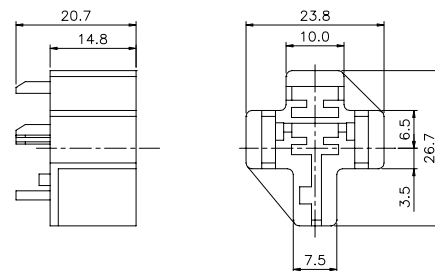
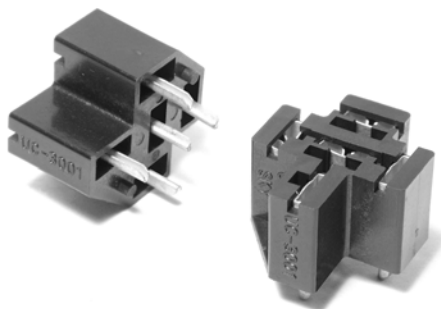

Appearance illustration

LED Module

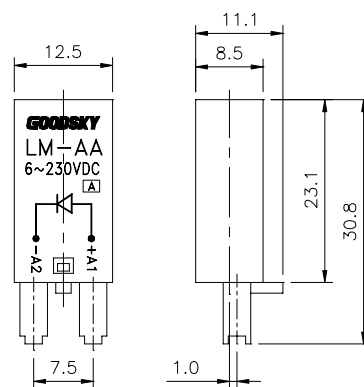

Appearance illustration

LED Module Wiring Diagrams

AC	AB	BC	BD	BE	CF	CG
CH	DI	DJ	DK	EL	EM	EN
FO	FP	FQ	FR	GR	GS	GT
HU	JV	JW	JX			

■ Retaining Clip for Sockets Ordering Information

B	P	-16	-P	S		
					Retainer Type:	Nil: Retainer (for DIN-Rail Socket) S: Simple Type
					Material:	P: Plastic M: Metal
					Suit Relay High:	-16: 15.0~16.5mm -20: 20.0~20.5mm -25: 25.0~25.5mm -29: 29mm (for PYF DIN-Rail Socket Only) -36: 34.6~35.7mm (for PYF DIN-Rail Socket only)
					Socket Type:	P: PCB Socket S: DIN-Rail Socket
					Item:	B: Retaining Clip

■ LED Module Ordering Information

LM	-AC	-G-		
			LED Color:	Nil: Red G: Green
			Area Code:	-AC, -AB -BC, -BD, -BE -CF, -CG, -CH -DI, -DJ, -DK -EL, -EM, -EN -FO, -FP, -FQ, FR -GR, -GS, -GT -HU JV, JW, JX
			Produce Name:	LM: LED Module